

NORMBAU

PASSION FOR CARE

Cavere®
FlexCare



ALLEGION

DE | EN





Cavere[®] Care

Barrierefreiheit mit Stil

Bei NORMBAU steht der Mensch mit seinen Bedürfnissen im Zentrum der Produktentwicklung. Der Ausgangspunkt für Cavere[®] Care war ein Design zu schaffen, welches den Alltag mit barrierefreien Produkten erleichtert, ohne dass die Ausstattung dergleichen andeutet. Mit Unterstützung der Produktdesigner von C.F. Møller Architects wurden Formgebung und Produktportfolio der Cavere[®] Serie überarbeitet und erweitert. Wesentlicher Bestandteil dieser Erweiterung ist das modulare und flexible Wandschienensystem Cavere[®] FlexCare.

Accessible design made stylish

At NORMBAU, people and their requirements are the number-one focus when it comes to product development. The starting point for Cavere[®] Care was to create a design that facilitates everyday life with barrier-free products without the fittings suggesting anything of the type. The design and product portfolio of the Cavere[®] series were revised and expanded with the support of the product designers from C.F. Møller Architects. An essential component of this expansion is the modular and flexible Cavere[®] FlexCare wall rail system.



Cavere® FlexCare

NEU
NEW

Flexibel für höchsten Komfort

Das neu entwickelte Schienensystem Cavere® FlexCare bringt mit vielfältigen Accessoires mehr Komfort und Flexibilität ins Bad. Das tragende Funktionsteil ist die Wandschiene Cavere® FlexRail. Es lassen sich vielseitige Accessoires einhängen, individuell positionieren und arretieren.

Herzstück der Serie ist die flexible Ablage Cavere® FlexTray. Auf einem Gelenkarm montiert, kann sie ausgeschwenkt und nach Gebrauch platzsparend eingeschwenkt werden.

Flexibility for maximum convenience

The newly developed Cavere® FlexCare rail system, with its various accessories, gives bathrooms added comfort and flexibility. The Cavere® FlexRail wall rail serves as a supporting functional component. You can now fix accessories to this wall rail in flexible positions.

The flexible Cavere® FlexTray is the centerpiece of the series. Installed on an articulated bracket, it can be swivelled out or in to save space when necessary.



Fließende Soft-Edge-Radien der Wandschiene unterstreichen die Erneuerung des emotionalen Designs, das die Ästhetik des Badezimmers charmant akzentuiert. Die trendbewusste Farbpalette mit den Tönen Carbonschwarz, Anthrazit-Metallic, Silber-Metallic, Satinbeige und klassischem Weiß passt sich individuellen Badeeinrichtungen an.

The seamless, soft-edge radii of the wall rail underline the renewal of the emotional design, which charmingly accentuates the aesthetic of any bathroom. The trend-conscious colour palette consisting of the tones carbon black, metallic anthracite, metallic silver, satin beige and classic white conforms to individual bathroom furnishings.





360°
VIEW

Trendfarben für Cavere® FlexCare

Trend colours for Cavere® FlexCare

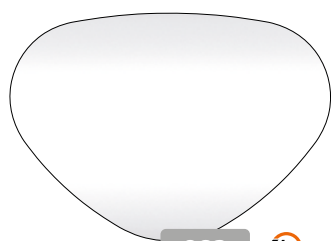

092 

Cavere Weiß
Cavere White

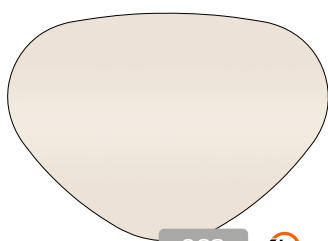

093 

Cavere Satinbeige
Cavere Satin Beige

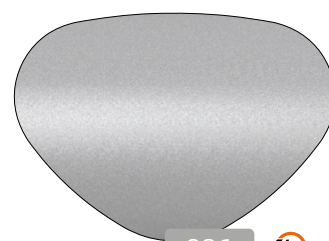

096 

Cavere Silber-Metallic
Cavere Metallic Silver



095 

Cavere Anthrazit-Metallic
Cavere Metallic Anthracite

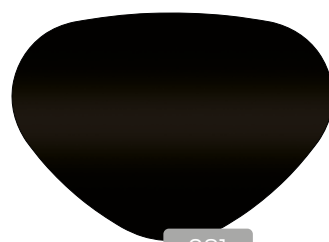

091

Cavere Carbonschwarz
Cavere Carbon Black



Designed by



www.cfmoller.com

Edel und langlebig

Mit Herzblut arbeiten unsere Entwickler an Produkten, die sowohl funktional als auch ästhetisch überzeugen.

Die sanft schimmernde, haptisch angenehme Oberfläche von Cavere® Care unterstreicht das edle Design der Serie. Attraktive Trendtöne harmonisieren mit unterschiedlichsten Einrichtungsstilen. Eine umweltfreundliche Pulverbeschichtung gewährleistet lange Lebensdauer und leichte Reinigung.

Elegant and durable

Our developers put their heart and soul into these products, which are effective in terms of both function and design.

The softly shimmering, haptically pleasing surface of Cavere® Care highlights the elegant design of the series. Attractive trend tones harmonise with a wide range of different interior styles. An environmentally-friendly powder coating ensures long-lasting durability and makes cleaning easy.



Antibac

Antibakterieller Hygieneschutz

NORMBAU baut auf die Ressourcenschonende Applikationstechnologie von Antibac mit Silberionen. Das Masterbatch wird mit dem Pulverlack vermischt und im Beschichtungsvorgang gleichmäßig auf das Produkt aufgetragen. Die so antibakteriell geschützte Oberfläche sorgt für eine erhöhte Sicherheit, das Wachstum von schädlichen Mikro-Organismen, wie Bakterien und Schimmel, wird verhindert.

Antibacterial hygiene protection

NORMBAU uses silver ions to enhance the resource-saving application technology of Antibac. The master batch is mixed into the powder coating and evenly applied to the product during the coating process. Protecting the surface against bacteria in this way ensures increased safety by preventing the growth of harmful micro-organisms such as bacteria and mould.





Cavere® FlexTray **NEU NEW**

Bereich Waschtisch und Wanne

Das Ablagesystem Cavere® FlexTray besteht aus einer Ablage und einem darunterliegenden Schwenkarm. Es lässt sich in einem Radius von 600 mm frei ausschwenken und positionieren. So haben Badnutzer am Waschtisch oder in der Wanne stets alles in Griffweite, was für die tägliche Körperpflege wichtig ist.

Wash basin and bathtub

The Cavere® FlexTray storage system consists of a tray and a swivel arm underneath. It can be freely swivelled out and positioned in a radius of 600mm. To have everything in reach what you need for your daily personal care is now possible due to this Cavere FlexTray storage system.

+ Ausladung maximal 600 mm,
Schwenkbereich 180°

Maximum storage 600mm,
swivel radius 180°

+ Ablage 150 x 300 mm

Tray 150 x 300mm



+ Einzel an der Wand oder
auf der FlexRail montierbar

Can be mounted to the
wall separately or to
the FlexRail system

+ Positioniert auf
Schwenkarm

Positioned onto the
swivel arm

+ Tragkraft max. 4 kg

Load capacity max. 4kg

+ Erhöhte Sicherheit durch
rutschfeste Silikoneinlage

Increased safety due to
non-slip silicone insert





Mit einer Tragkraft von bis zu 4 kg ist die Ablage sehr belastbar. Dank der cleveren Konstruktion überdeckt sie beim Zurückschieben an die Wand den Schwenkarm und macht ihn nahezu unsichtbar.

The tray has a load capacity of up to 4kg, making it very robust. Thanks to its elaborated construction, it overlaps the swivel arm when you slide it back towards the wall, making it virtually invisible.



Kleben statt Bohren

Gluing instead of drilling

NEU
NEW



Design trifft auf intelligente Klebetechnik

Um noch mehr Flexibilität in der Raumgestaltung zu ermöglichen, haben unsere Entwickler die Klebetechnik in das Produktportfolio von Cavere® FlexCare integriert. So lässt sich die Wandschiene FlexRail als Grundelement für alle Accessoires individuell und bohrfrei an jeder Fliese befestigen – ob am Waschbecken, der Badewanne, der Dusche oder sogar in der Küche. Die wasserresistente Verklebung macht Projekte ganz ohne Werkzeug, Lärm und Schmutz realisierbar.

Design meets intelligent gluing technology

To allow even more flexibility in room design, our developers have integrated gluing technology into the Cavere® FlexCare product portfolio. This means that the FlexRail, as a basic element for all accessories, can be attached individually and without drilling to any tile - whether at the washbasin, the bathtub, the shower area or even in the kitchen. The water-resistant adhesion makes projects possible without any tools, noise or dirt.

+ Einfache Handhabung: Montage ohne Werkzeug, Lärm und Schmutz
Easy handling: Assembly without tools, noise and dirt

+ Schnelle Aushärtezeit von nur 12 Stunden
Quick curing time of only 12 hours

+ Noch höhere Flexibilität, da rückstandslos entfernbar
Even more flexibility, as it can be removed without leaving any residue



Aluminium Montageleiste des FlexRail
Aluminium base bar of the FlexRail







Beispielkombinationen von Cavere FlexCare
Example combinations of Cavere FlexCare

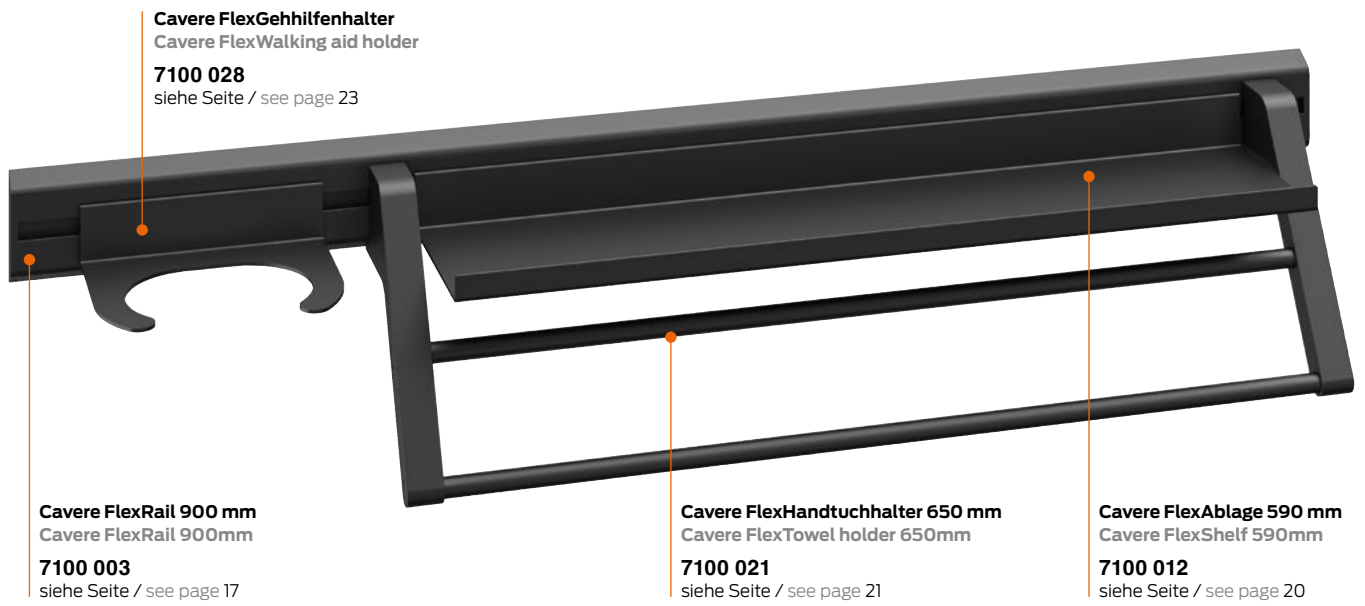

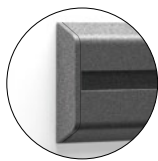
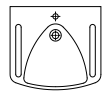

...inklusive Endkappen
...end caps included

| FlexRail | Code | PG 7010 |
|---|-----------------|----------|
| FlexRail | | |
| ▶ L= 300 mm* | 7100 001 | 80,50 € |
| ▶ L= 660 mm* | 7100 002 | 103,00 € |
| ▶ L= 900 mm* | 7100 003 | 125,00 € |
| ▶ Ersatz-Endkappen, 2 Stück (rechte und linke Seite) End caps for replacement, 2 pieces (right and left side) | 7100 005 | 16,00 € |

Cavere FlexRail

- Grundelement für das Cavere FlexCare Schienensystem,
- * Gesamtlänge 310, 670 und 910 mm (inkl. 10 mm für Endkappen),
- aus Aluminium,
- kratzfeste Pulverbeschichtung mit antibakteriellem Schutz (ausgenommen 091 Carbonschwarz), siehe Register Information,
- lieferbar in den Cavere Farben,
- Einhängeschiene für die Cavere FlexCare Accessoires,
- Cavere FlexRail zweiteilig bestehend aus: Montageleiste und der darin einhängbaren Wandschiene,
- Lieferung mit Edelstahl Torx-Schrauben Ø 5 x 60 mm und Dübel für Vollbaustoffe,
- kann mit dem Klebe-Montageset (siehe unten) auch bohrfrei an Fliesen befestigt werden.

Cavere FlexRail

- base element for the Cavere FlexCare rail system,
- * total length 310, 670 and 910mm (incl. 10mm for end caps),
- made of aluminium
- scratch-resistant powder coating with antibacterial protection (except 091 carbon black), see register information,
- available in the Cavere colours,
- mounting rail for the Cavere FlexCare accessories,
- Cavere FlexRail consisting of two pieces: base bar and wall rail (clipped on it),
- supplied with 5mm dia. x 60mm stainless steel Torx screws and dowels for solid building materials,
- can also be attached to tiles without drilling using the glue fixing set (see below).

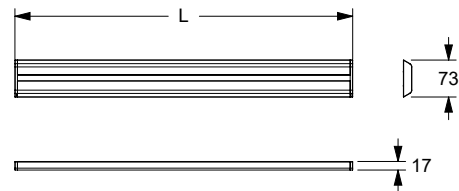

NEW



| Klebe-Montageset | Code | PG 7010 |
|------------------|-----------------|---------|
| Glue fixing set | | |
| ▶ Set Set | 7100 006 | 14,50 € |

Klebe-Montageset

- zur bohrfreien Befestigung der Aluminium-Montageleiste des FlexRail an Fliesen,
- rückstandslos entfernbar,
- max. zul. Belastung des FlexRail mit Klebetechnik: 4 kg,
- Aushärtezeit des Klebstoffs: 12 Stunden,
- Set bestehend aus: Klebebeutel 11g, Klebestreifen, Reinigungstuch,
- 24 Monate Mindesthaltbarkeitsdatum,
- empfohlene Bestellmenge: FlexRail 300 mm – 1 Set, FlexRail 660 mm – 2 Sets, FlexRail 900 mm – 3 Sets.

Glue fixing set

- for fixing of the aluminium base bar of the FlexRail to tiles without drilling,
- can be removed without residues,
- maximum loading permitted of FlexRail with glue technology: 4kgs,
- curing time of the glue: 12 hours,
- set consists of: glue bag 11g, glue strips, cleaning cloth,
- 24 months best-before date,
- recommended order quantity: FlexRail 300mm – 1 set, FlexRail 660mm – 2 sets, FlexRail 900mm – 3 sets.



NEW

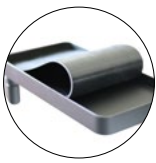
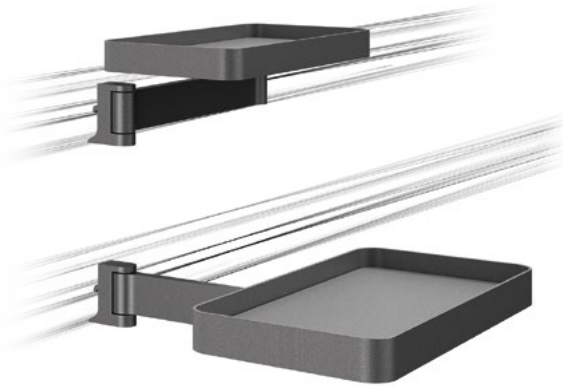

...inklusive Silikoneinlage
...silicone insert included

Cavere FlexTray

- zum Einhängen in Cavere FlexRail
- Gesamtmaß 308 x 158 x 104 mm,
- Ablage 303 x 153 x 30 mm, ca. 465 cm²,
- aus Aluminium
- kratzfeste Pulverbeschichtung mit antibakteriellem Schutz (ausgenommen 091 Carbonschwarz), siehe Register Information,
- lieferbar in den Cavere Farben,
- Ablage und darunterliegender Schwenkarm mit einer Ausladung von 600 mm,
- Flexibler Schwenkbereich bis 180 Grad,
- Ablage mit rutschhemmender Silikoneinlage in den Farben:
schwarz für FlexTray Farbe 091,
transparent für FlexTray Farben 092/093,
grau für FlexTray Farben 095/096,
- max. zulässige Belastung: 4 kg,
- verdeckte Fixierung des FlexTray durch die mitgelieferte Schraube,
- passend für das Cavere FlexCare Schienensystem,
- kombinierbar mit Cavere FlexWandhalterung (zur nachträglichen Wandmontage).

Cavere FlexTray

- for mounting onto the Cavere FlexRail
- overall dimensions 308 x 158 x 104mm,
- tray 303 x 153 x 30mm, approx. 465cm²,
- made of aluminium,
- scratch-resistant powder coating with antibacterial protection (except 091 carbon black), see register information,
- available in the Cavere colours,
- tray and swivel arm, underneath with a radius of 600mm,
- flexible swivel radius of up to 180 degrees,
- tray with anti-slip silicone insert in the colours:
black for FlexTray colour 091,
transparent for FlexTray colours 092/093,
grey for FlexTray colours 095/096,
- max. permissible load capacity: 4kgs,
- concealed fixing of the FlexTray due to the screw supplied,
- suitable for the Cavere FlexCare rail system,
- can be combined with Cavere FlexWall bracket (for later wall fixing).

| FlexTray FlexTray | Code | PG 7010 |
|--|-----------------|----------|
| ▶ 308 x 158 x 104 mm ☞ | 7100 040 | 170,00 € |
| ▶ 308 x 158 x 104 mm ☞ | 7100 050 | 170,00 € |
| ▶ Ersatz-Silikoneinlage transparent (000) Silicone insert for replacement transparent (000) | 7100 060 | 16,00 € |
| ▶ Ersatz-Silikoneinlage schwarz (091) Silicone insert for replacement black (091) | 7100 061 | 16,00 € |
| ▶ Ersatz-Silikoneinlage grau (095) Silicone insert for replacement grey (095) | 7100 062 | 16,00 € |

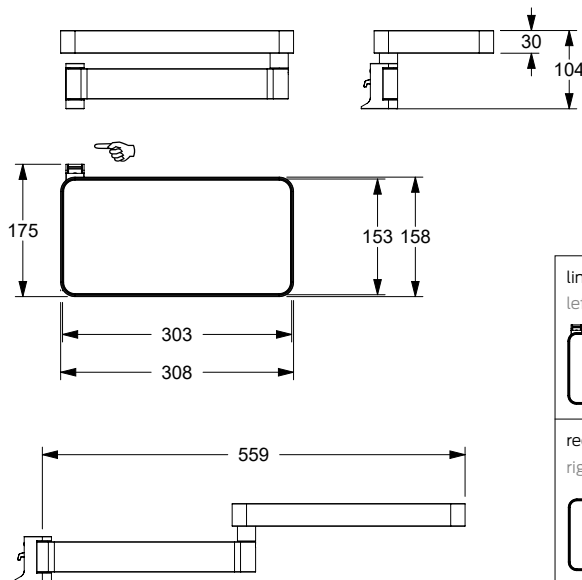

NEW



Cavere FlexWandhalterung

- zur nachträglichen Wandmontage von Cavere FlexTray und Cavere FlexHandtuchhalter
- Gesamtmaß 24 x 60 x 25 mm,
- aus Aluminium
- lieferbar in den Cavere Farben,
- Lieferung mit Edelstahl Torx-Schrauben Ø 8 x 80 mm und Dübel für Vollbaustoffe,
- verdeckte Verschraubung.

Cavere FlexWall bracket

- for later wall fixing of Cavere FlexTray and Cavere FlexTowel holder,
- overall dimensions 24 x 60 x 25mm,
- made of aluminium,
- available in the Cavere colours,
- supplied with Ø 8 x 80mm stainless steel Torx screws and dowels for solid building materials,
- concealed screw fixing.

| FlexWandhalterung FlexWall bracket | Code | PG 7010 |
|---------------------------------------|-----------------|---------|
| ▶ 24 x 60 x 25 mm | 7100 025 | 20,00 € |

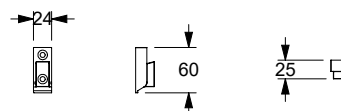

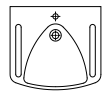

NEW

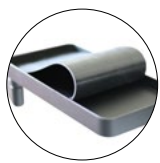
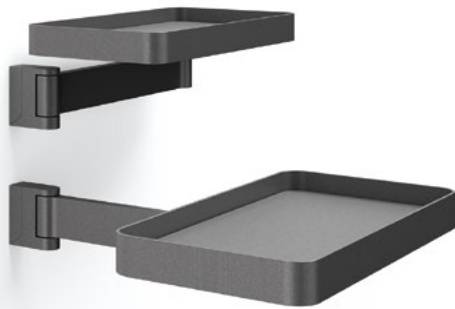

...inklusive Silikoneinlage
...silicone insert included

Cavere FlexTray

... zur Wandmontage

- mit Wandhalterung,
- Lieferung mit Edelstahl Torx-Schrauben $\varnothing 8 \times 80$ mm und Dübel für Vollbaustoffe,
- verdeckte Verschraubung,
- weitere Beschreibung siehe links.

Cavere FlexTray

... wall mounting

- with wall bracket,
- supplied with 8mm dia. x 80mm stainless steel Torx screws and dowels for solid building materials,
- concealed screw fixing,
- for further description, see left side.

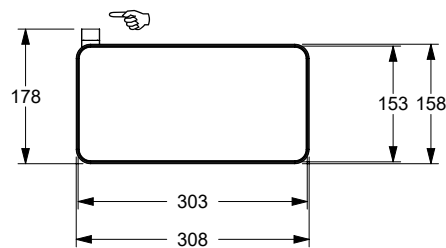
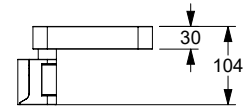
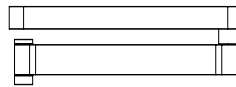

| FlexTray | Code | PG 7010 |
|--|-----------------|----------|
| FlexTray | | |
| ... zur Wandmontage ... wall mounting | | |
| ▶ 308 x 158 x 104 mm ☞ | 7100 041 | 190,00 € |
| ▶ 308 x 158 x 104 mm ☜ | 7100 051 | 190,00 € |
| ▶ Ersatz-Silikoneinlage transparent (000) Silicone insert for replacement transparent (000) | 7100 060 | 16,00 € |
| ▶ Ersatz-Silikoneinlage schwarz (091) Silicone insert for replacement black (091) | 7100 061 | 16,00 € |
| ▶ Ersatz-Silikoneinlage grau (095) Silicone insert for replacement grey (095) | 7100 062 | 16,00 € |



NEW



Cavere FlexAblage

- zum Einhängen in Cavere FlexRail,
- 290 x 123 x 38 mm, ca. 356 cm²,
400 x 123 x 38 mm, ca. 492 cm²,
590 x 123 x 38 mm, ca. 726 cm²,
- aus Aluminium,
- kratzfeste Pulverbeschichtung mit antibakteriellem Schutz (ausgenommen 091 Carbonschwarz), siehe Register Information,
- lieferbar in den Cavere Farben,
- max. zulässige Belastung: 10 kg,
- platzsparend einhängbar zwischen den Bügeln des Cavere FlexHandtuchhalters,
- passend für das Cavere FlexCare Schienensystem.

Cavere FlexShelf

- for mounting onto the Cavere FlexRail,
- 290 x 123 x 38mm, approx. 356cm²,
400 x 123 x 38mm, approx. 492cm²,
590 x 123 x 38mm, approx. 726cm²,
- made of aluminium,
- scratch-resistant powder coating with antibacterial protection (except 091 carbon black), see register information,
- available in the Cavere colours,
- max. permissible load capacity: 10kgs,
- can be mounted between the brackets of the Cavere FlexTowel holder,
- suitable for the Cavere FlexCare rail system.

FlexAblage FlexShelf

Code PG 7010

| | | |
|-------------|-----------------|---------|
| ▶ L= 290 mm | 7100 010 | 50,00 € |
| ▶ L= 400 mm | 7100 011 | 58,00 € |
| ▶ L= 590 mm | 7100 012 | 71,50 € |

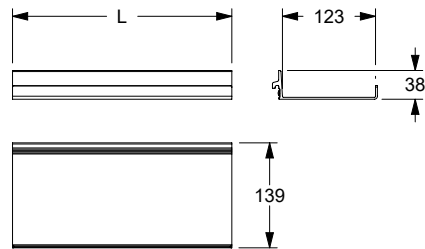

NEW



Cavere FlexHaken

- zum Einhängen in Cavere FlexRail,
- 95 x 55 x 70 mm,
- aus Aluminium,
- kratzfeste Pulverbeschichtung mit antibakteriellem Schutz (ausgenommen 091 Carbonschwarz), siehe Register Information,
- lieferbar in den Cavere Farben,
- 3-fach Haken,
- zum Aufhängen oder Einklemmen von Hand- und Badetüchern,
- passend für das Cavere FlexCare Schienensystem.

Cavere FlexHook

- for mounting onto the Cavere FlexRail,
- 95 x 55 x 70mm,
- made of aluminium,
- scratch-resistant powder coating with antibacterial protection (except 091 carbon black), see register information,
- available in the Cavere colours,
- triple hook,
- for hanging or clamping hand and bath towels,
- suitable for the Cavere FlexCare rail system.

FlexHaken FlexHook

Code PG 7010

| | | |
|-------------------|-----------------|---------|
| ▶ 95 x 55 x 70 mm | 7100 029 | 25,50 € |
|-------------------|-----------------|---------|

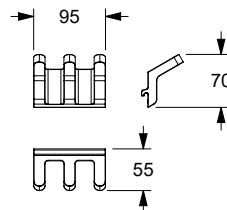

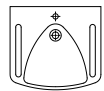

NEW



Cavere FlexHandtuchhalter

- zum Einhängen in Cavere FlexRail,
- Länge 500 mm und 650 mm,
- aus Aluminium,
- kratzfeste Pulverbeschichtung mit antibakteriellem Schutz (ausgenommen 091 Carbonschwarz), siehe Register Information,
- lieferbar in den Cavere Farben,
- Halter mit zwei Handtuchstangen,
- zwischen den Bügeln besteht die Möglichkeit der Platzierung von Cavere FlexAblage und / oder Haken, 450 und 600 mm stehen dafür zur Verfügung,
- passend für das Cavere FlexCare Schienensystem,
- kombinierbar mit Cavere FlexWandhalterung (zur nachträglichen Wandmontage).

Cavere FlexTowel holder

- for mounting onto the Cavere FlexRail,
- lengths 500mm and 650mm,
- made of aluminium,
- scratch-resistant powder coating with antibacterial protection (except 091 carbon black), see register information,
- available in the Cavere colours,
- towel holder with two bars,
- you can also add a Cavere FlexTray and / or hooks to the FlexRail. Available space 450 or 600mm,
- suitable for the Cavere FlexCare rail system.
- can be combined with Cavere FlexWall bracket (for later wall fixing).

FlexHandtuchhalter Code PG 7010
FlexTowel holder

- ▶ L1 = 500 mm L2 = 450 mm **7100 020** 144,00 €
- ▶ L1 = 650 mm L2 = 600 mm **7100 021** 150,00 €

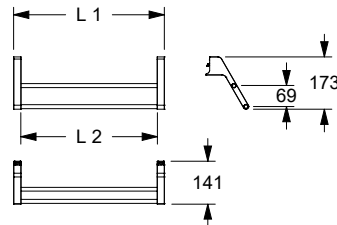

... zur Wandmontage

- mit Wandhalterung,
- Lieferung mit Edelstahl Torx-Schrauben Ø 6 x 70 mm und Dübel für Vollbaustoffe,
- verdeckte Verschraubung,
- weitere Beschreibung siehe oben.

... wall mounting

- with wall bracket,
- supplied with 6mm dia. x 70mm stainless steel Torx screws and dowels for solid building materials,
- concealed screw fixing,
- for further description, see above.

... zur Wandmontage
... wall mounting

- ▶ L1 = 500 mm L2 = 450 mm **7100 022** 185,00 €
- ▶ L1 = 650 mm L2 = 600 mm **7100 023** 190,00 €

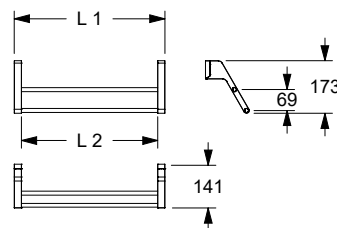



NEW



Cavere FlexSeifenspender

- zum Einhängen in Cavere FlexRail,
- 90 x 104 x 168 mm,
- aus Aluminium,
- kratzfeste Pulverbeschichtung mit antibakteriellem Schutz (ausgenommen 091 Carbonschwarz), siehe Register Information,
- Halterung lieferbar in den Cavere Farben,
- Spender aus verchromtem Metall,
- Glasflasche aus satiniertem Glas,
- Fassungsvermögen 200 ml,
- passend für das Cavere FlexCare Schienensystem.

Cavere FlexSoap dispenser

- for mounting onto the Cavere FlexRail,
- 90 x 104 x 168mm,
- made of aluminium
- scratch-resistant powder coating with antibacterial protection (except 091 carbon black), see register information,
- holding device available in the Cavere colours,
- dispenser made of chromium-plated metal,
- glass bottle made of satined glass,
- capacity 200ml,
- suitable for the Cavere FlexCare rail system.

| | | |
|---------------------------|------|---------|
| FlexSeifenspender | Code | PG 7010 |
| FlexSoap dispenser | | |

| | | |
|---------------------|-----------------|----------|
| ▶ 90 x 104 x 168 mm | 7100 026 | 154,00 € |
|---------------------|-----------------|----------|

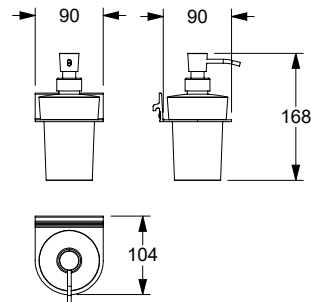

NEW



Cavere FlexSeifenablage

- zum Einhängen in Cavere FlexRail,
- 90 x 104 x 52 mm,
- aus Aluminium,
- kratzfeste Pulverbeschichtung mit antibakteriellem Schutz (ausgenommen 091 Carbonschwarz), siehe Register Information,
- Halterung lieferbar in den Cavere Farben,
- Ablageschale aus Glas, zur Reinigung abnehmbar,
- passend für das Cavere FlexCare Schienensystem.

Cavere FlexSoap dish

- for mounting onto the Cavere FlexRail,
- 90 x 104 x 52mm,
- made of aluminium,
- scratch-resistant powder coating with antibacterial protection (except 091 carbon black), see register information,
- available in the Cavere colours,
- glass storage tray, can be removed for cleaning,
- suitable for the Cavere FlexCare rail system.

| | | |
|-------------------------|------|---------|
| FlexSeifenablage | Code | PG 7010 |
| FlexSoap dish | | |

| | | |
|--------------------|-----------------|---------|
| ▶ 90 x 104 x 52 mm | 7100 027 | 77,50 € |
|--------------------|-----------------|---------|

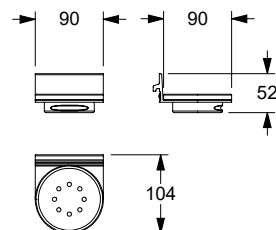



NEW



Cavere FlexBecher-/Glashalter mit Becher/Glas

- zum Einhängen in Cavere FlexRail,
- 90 x 104 x 52 mm,
- aus Aluminium,
- kratzfeste Pulverbeschichtung mit antibakteriellem Schutz (ausgenommen 091 Carbonschwarz), siehe Register Information,
- Halterung lieferbar in den Cavere Farben,
- Becher aus bruchgeschütztem Kunststoff,
- Glas aus Klarglas,
- passend für das Cavere FlexCare Schienensystem.

Cavere FlexTumbler/Glass holder with tumbler/glass

- for mounting onto the Cavere FlexRail,
- 90 x 104 x 52mm,
- made of aluminium,
- scratch-resistant powder coating with antibacterial protection (except 091 carbon black), see register information,
- holding device available in the Cavere colours,
- tumbler made of break-resistant plastic,
- glass made of clear glass,
- suitable for the Cavere FlexCare rail system.

FlexBecher-/Glashalter Code PG 7010
FlexTumbler/Glass holder

mit Becher / with tumbler

| | | |
|-----------------------------------|-----------------|---------|
| ▶ 90 x 104 x 52 mm | 7100 030 | 77,50 € |
| ▶ Ersatzbecher / tumbler (single) | 7500 480 | 25,75 € |

mit Glas / with glass

| | | |
|---------------------------------------|-----------------|---------|
| ▶ 90 x 104 x 52 mm | 7100 031 | 77,50 € |
| ▶ Ersatzglas / glass tumbler (single) | 7500 490 | 25,75 € |

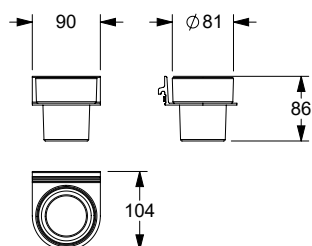

NEW



Cavere FlexGehhilfenhalter

- zum Einhängen in Cavere FlexRail,
- 158 x 130 x 38 mm,
- aus Aluminium,
- kratzfeste Pulverbeschichtung mit antibakteriellem Schutz (ausgenommen 091 Carbonschwarz), siehe Register Information,
- lieferbar in den Cavere Farben,
- zum Abstellen von Gehhilfen,
- passend für das Cavere FlexCare Schienensystem.

Cavere FlexWalking aid holder

- for mounting onto the Cavere FlexRail,
- 158 x 130 x 38mm,
- made of aluminium,
- scratch-resistant powder coating with antibacterial protection (except 091 carbon black), see register information,
- available in the Cavere colours,
- for parking the walking aids,
- suitable for the Cavere FlexCare rail system.

FlexGehhilfenhalter Code PG 7010
FlexWalking aid holder

| | | |
|---------------------|-----------------|---------|
| ▶ 158 x 130 x 38 mm | 7100 028 | 77,50 € |
|---------------------|-----------------|---------|

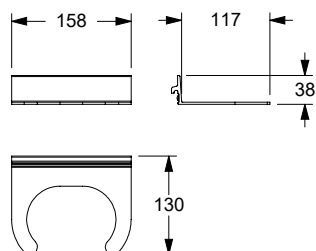

Über Allegion™

Allegion (NYSE: ALLE) ist ein internationaler Anbieter im Bereich Sicherheit mit führenden Marken wie CISA®, Interflex®, LCN®, NORMBAU, Schlage® und Von Duprin®. Mit dem Schwerpunkt auf Sicherheit rund um Türen und Zutritt bietet Allegion ein breites Spektrum an Lösungen für Privathaushalte, Firmen, Schulen und andere Einrichtungen. Allegion erwirtschaftet einen Umsatz von 2 Mrd. US-Dollar und vertreibt seine Produkte in rund 130 Ländern weltweit.

Weitere Informationen unter www.allegion.com

About Allegion™

Allegion (NYSE: ALLE) is a global pioneer in safety and security, with leading brands like CISA®, Interflex®, LCN®, NORMBAU, Schlage® and Von Duprin®. Focusing on security around the door and adjacent areas, Allegion produces a range of solutions for homes, businesses, schools and other institutions. Allegion is a \$2 billion company, with products sold in almost 130 countries.

For more, visit www.allegion.com.

AXA ■  BRICARD ■ Briton ■  CISA ■  interflex ■ KRYPTONITE ■ NORMBAU ■  Simons Voss technologies ■  TRELOCK



Weitere Informationen und **alle technischen Details** unserer Produkte finden Sie auf unserer Website. Hier können Sie direkt die **Cavere Care Broschüre** und den **Care Solutions Katalog** downloaden.

Further information and **all technical details** of our products can be found on our website. Here you can download the **Cavere Care brochure** and the **Care Solutions catalogue**.



www.normbau.de

NORMBAU GmbH
Schwarzwaldstraße 15
77871 Renchen | Germany
Telefon +49 7843 704-0
Telefax +49 7843 704-63
www.normbau.de
normbau@allegion.com

